

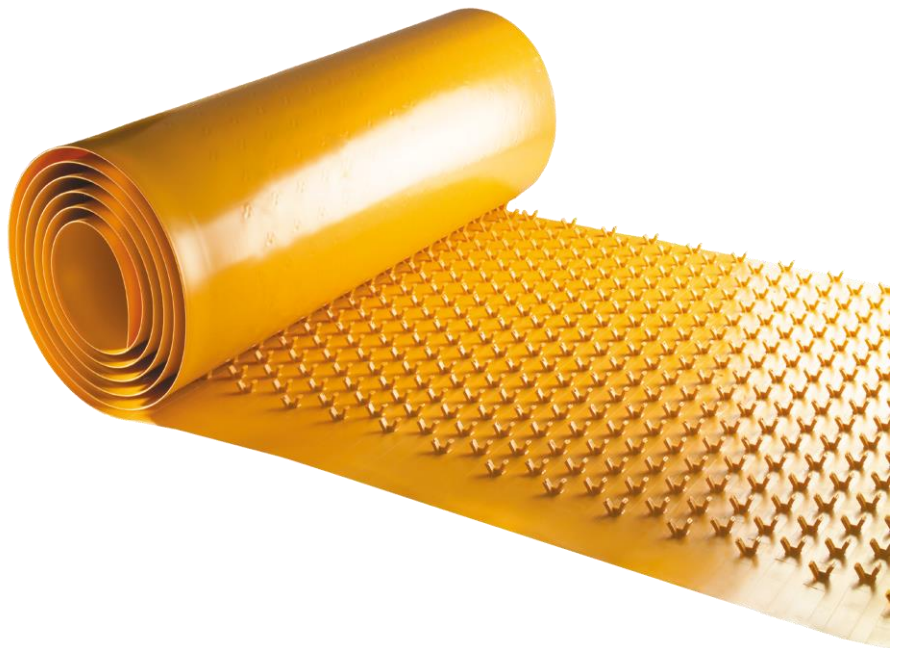

P: 3205 6668  
M: : 0414 511 502  
E: admin@pesolutions.net.au  
ABN: 981 5991 0406

1 LEONARD CRESENT, BRENDALD QLD 4500  
PO BOX 5428, BRENDALD QLD 4500  
www.pesolutions.net.au

# POLYETHYLENE NUSEWER PIPE AND FITTINGS SYSTEM





P: 3205 6668  
M: : 0414 511 502  
E: admin@pesolutions.net.au  
ABN: 981 5991 0406

1 LEONARD CRESENT, BRENDALE QLD 4500  
PO BOX 5428, BRENDALE QLD 4500  
www.pesolutions.net.au

## Table of Contents

<b>Welcome to PE Solutions</b> .....	<b>1</b>
<b>Disclaimer</b> .....	<b>1</b>
<b>Nusewer System</b> .....	<b>2</b>
Hi Vis Pipe Metric SDR21 .....	2
45° Electrofusion Wastewater Saddles .....	2
Electrofusion Couplers Light Fit SDR21 Suitable .....	2
Electrofusion Wipes.....	2
88° Sweep Junctions (Extended branches to suit bitt-welding and electrofusion) .....	3
Reducing .....	3
Equal .....	3
Capped (Type C).....	3
45° Junctions (Extended branches to suit butt-welding and electrofusion) .....	3
Reducing .....	3
Equal .....	3
Nusewer Sweep Bends 15° .....	4
Nusewer Sweep Bends 30° .....	4
Nusewer Sweep Bends 45° .....	4
Nusewer Sweep Bends 90° .....	4
DN110 Polyethylene Sediment Trap with PVC Cap & Coupling .....	5
Polyethylene Rubber Ring Sockets SDR21 .....	5
PVC Access Spigot Couplings with Cap .....	5
Level Invert Taper Long Spigot SDR21 .....	5
Hydrotite .....	5
MH Connector with Hydrophilic Seals.....	6
External 45° Backdrop Junction Fitted with Hydrophilic Seals .....	6
Backdrop Tee Fitted with Hydrophilic Seals .....	6
Backdrop Bend Fitted with Hydrophilic Seals .....	6
DN160 Internal Backdrop Bend .....	7
Concrete Protection .....	7
Vactor Pipe Assembly c/w S/S Bracket & Air Line.....	7
S/S Wall Pipe c/w Poly Sleeve.....	7
<b>Contact Us</b> .....	<b>8</b>





P: 3205 6668  
M: : 0414 511 502  
E: admin@pesolutions.net.au  
ABN: 981 5991 0406

1 LEONARD CRESENT, BRENDALE QLD 4500  
PO BOX 5428, BRENDALE QLD 4500  
www.pesolutions.net.au

## Welcome to PE Solutions

Welcome to PE Solutions Pty Ltd - Specialists in PE Fabrication & Supply.

With over 20 years experience in the poly industry, I have developed an in-depth knowledge of products, fabrications, operations, sales and management. I take pride in knowing that I have been committed to the industry and look forward to the future of poly in Australia.

At PE Solutions customer service is always a priority; our aim is to provide you with the highest standard and quality of products available in the industry. The key areas for development at PE Solutions will be focusing on the mining, commercial, civil, water, sewerage, gas, agricultural and marine industries in all aspects of sales, fabrication and supply.

Products will include the complete range of Poly Butt-weld, Electrofusion fittings and fabrications ranging in size from 16mm to 1600mm. All work will be carried out by only fully accredited poly welders to the highest standard. This means if its poly, PE Solutions is your best contact.

I look forward to a prosperous business relationship with you and your company, if I can be of any assistance at all please contact me on the details provided



### Important Disclaimer

Information in this brochure is subject to change and should be used as a guide only. Liability for such information is excluded PE Solutions Pty Ltd does not invite any person to act or reply upon such information. Product designs, specifications and components may change as new technology is developed rapidly and PE Solutions Pty Ltd reserves the right to make changes at its own discretion.

The information contained in this brochure does not constitute the description of any products to be supplied by PE Solutions Pty Ltd or its distributors and it also does not form part of the terms and conditions of sale. Customers should seek expert advice on their particular intended application and use for the product and source current product information from their distributor before purchasing a product.

Copyright © 2016 PE Solutions Pty Ltd. This brochure or any portion thereof may not be reproduced or used in any manner whatsoever without the express written permission of PE Solutions Pty Ltd.



## Nusewer System

### Hi Vis Pipe Metric SDR21:

Product code	Typical Dimension		List \$ each
	Nominal Diameter DN (mm)	Nominal Length (Meters)	
10903grey	90	12 & 6	\$9.00
11103grey	110	12 & 6	\$11.25
11603grey	160	12 & 6	\$22.00
12503grey	250	12 & 6	\$48.00
13153grey	315	12 & 6	\$99.00
14003grey	400	12 & 6	\$125.00

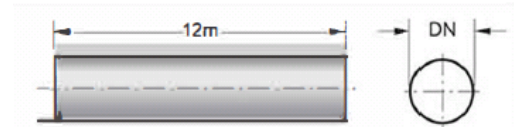

Note: Additional pipe sizes, classes and lengths are available upon request

### 45° Electrofusion Wastewater Saddles:

Product code	Typical Dimension Dia. (mm) 'A'	List \$ each
EFS160110	160	POA
EFS250110	225-250	POA

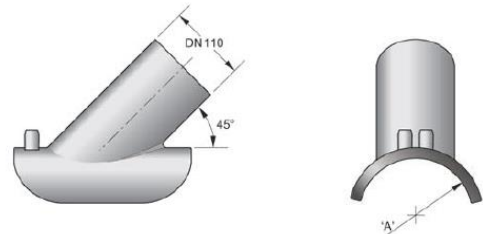

### Electrofusion Couplers Light fit SDR21 Suitable:

Product code	Typical Dimension		List \$ each
	Nominal Diameter DN (mm)	Dim. (mm) 'A'	
EFCL090	90	130	\$10.00
EFCL110	110	145	\$11.00
EFCL160	160	180	\$22.00
EFCL250	250	244	\$82.00
EFCL315	315	268	\$118.00
EFCL400	400	246	\$219.00

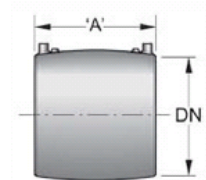

### Electrofusion Wipes:

Product code	Description	List \$ p/Mtr
EFWIPES	70% Isopropyl Alcohol Wipes 75 per pack	\$15.00



Note:

- Additional Pipe and Fitting sizes are available upon request. Please check with your customer service representative for details
- All dimensions, masses & volumes are approximate only. If critical contact PE Solutions
- Unless otherwise stated all dimensions are in mm
- Full range of Electrofusion products and hire equipment available on request

## Nusewer System

### 88° Sweep Junctions (Extended branches to suit butt-welding and electrofusion):

#### Reducing:

Product code	Typical Dimension				List \$ each
	Nominal Diameter DN (mm)	Dim. (mm) 'A'	Dim. (mm) 'B'	Dim. (mm) 'C'	
NS16011088	160	815	270	110	\$206.00
NS25011088	250	1030	360	110	\$256.00
NS25016088	250	1140	360	160	\$375.00

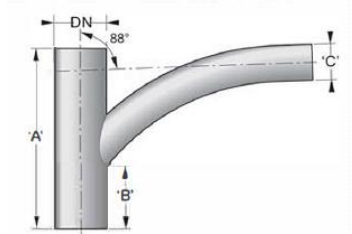

#### Equal:

Product code	Typical Dimension				List \$ each
	Nominal Diameter DN (mm)	Dim. (mm) 'A'	Dim. (mm) 'B'	Dim. (mm) 'C'	
NS11088	110	715	220	110	\$225.00
NS16088	160	885	270	160	\$360.00

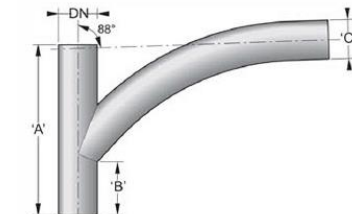

#### Capped (Type C):

Product code	Typical Dimension				List \$ each
	Nominal Diameter DN (mm)	Dim. (mm) 'A'	Dim. (mm) 'B'	Dim. (mm) 'C'	
NS11088C	110	715	220	110	\$275.00
NS16088C	160	885	270	160	\$420.00

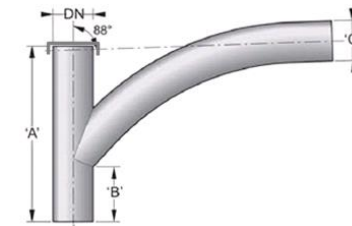

### 45° Junctions (Extended branches to suit butt-welding and electrofusion):

#### Reducing:

Product code	Typical Dimension					List \$ each
	Nominal Diameter DN (mm)	Dim. (mm) 'A'	Dim. (mm) 'B'	Dim. (mm) 'C'	Dim. (mm) 'D'	
NS16011045	160	815	270	450	110	\$120.00
NS25011045	250	1030	360	450	110	\$168.00
NS25016045	250	1140	360	550	160	\$218.00

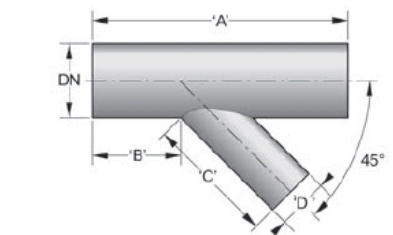

#### Equal:

Product code	Typical Dimension				List \$ each
	Nominal Diameter DN (mm)	Dim. (mm) 'A'	Dim. (mm) 'B'	Dim. (mm) 'C'	
NS11045	110	715	220	450	\$137.00
NS16045	160	885	270	550	\$200.00
NS25045	250	1270	360	800	\$295.00

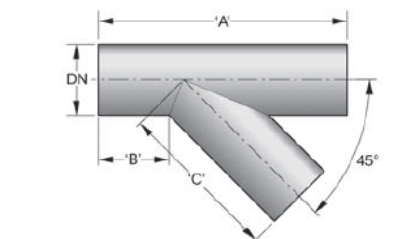

- All dimensions, masses & volumes are approximate only. If critical contact PE Solutions
- Unless otherwise stated all dimensions are in mm

## Nusewer System

### Nusewer Sweep Bends 15°:

Product code	Typical Dimension			List \$ each
	Nominal Diameter DN (mm)	Angle of Bend (°) 'A'	Dim. (mm) 'B'	
NS5110315	110	15	110	\$75.00
NS5160315	160	15	160	\$160.00
NS5250315	250	15	250	\$402.00
NS5315315	315	15	315	POA

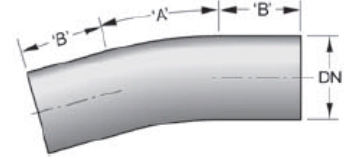

### Nusewer Sweep Bends 30°:

Product code	Typical Dimension			List \$ each
	Nominal Diameter DN (mm)	Angle of Bend (°) 'A'	Dim. (mm) 'B'	
NS5110330	110	30	110	\$75.00
NS5160330	160	30	160	\$160.00
NS5250330	250	30	250	\$402.00
NS5315330	315	30	315	POA

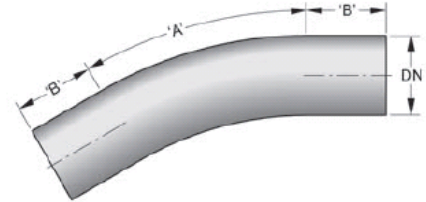

### Nusewer Sweep Bends 45°:

Product code	Typical Dimension			List \$ each
	Nominal Diameter DN (mm)	Angle of Bend (°) 'A'	Dim. (mm) 'B'	
NS5110345	110	45	110	\$75.00
NS5160345	160	45	160	\$160.00
NS5250345	250	45	250	\$402.00
NS5315345	315	45	315	POA

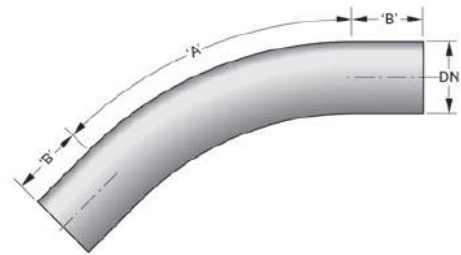

### Nusewer Sweep Bends 90°:

Product code	Typical Dimension			List \$ each
	Nominal Diameter DN (mm)	Angle of Bend (°) 'A'	Dim. (mm) 'B'	
NS5110390	110	90	110	\$105.00
NS5160390	160	90	160	\$210.00
NS5250390	250	90	250	\$504.00
NS5315390	315	90	315	POA



- All dimensions, masses & volumes are approximate only. If critical contact PE Solutions
- Unless otherwise stated all dimensions are in mm

## Nusewer System

### DN110 Polyethylene Sediment Trap with PVC Cap & Cap Coupling:

Product code	Description	List \$ each
NS110160SED	110x160 PE100 SewerPlex Trap Sediment - CW SP ACC Coup	\$160.00

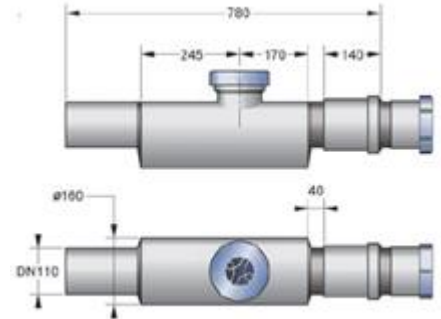

### Polyethylene Rubber Ring Sockets SDR21:

Product code	Description	Typical Dimensions		List \$ each
		Nominal Diameter DN (mm)	Dim. (mm) 'A'	
NS110PEPVC	110mm Socket RRJ Adaptor PE to PVC	110	300	\$43.00
NS160PEPVC	160mm Socket RRJ Adaptor PE to PVC	160	300	\$65.00

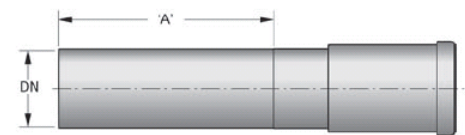

### PVC Access Spigot Couplings with Cap:

Product code	Description	Typical Dimension s Nominal Diameter DN (mm)	List \$ each
NS100PVCIO	100mm PVC Acc Spigot Coupling CW Cap	110	\$13.00
NS150PVCIO	150mm PVC Acc Spigot Coupling CW Cap	160	\$45.00

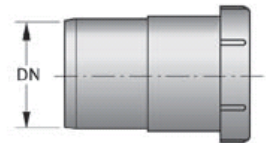

### Level Invert Taper Long Spigot SDR21:

Product code	Description	List \$ each
NS160110LIT	160x110 Level Invert Taper Long Spigot SDR21	\$44.00

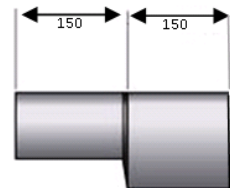

### Hydrotite:

Product code	Description	List \$ p/Mtr
Hydro202	Hydrotite DSSO220 ADH/Back Per Mtr	\$28.00



- All dimensions, masses & volumes are approximate only. If critical contact PE Solutions
- Unless otherwise stated all dimensions are in mm

## Nusewer System

### MH Connector with Hydrophilic Seals:

Product code	Typical Dimension		List \$ each
	Nominal Diameter DN (mm)	Dim. (mm) 'A'	
NS110MHC	110	250	\$100.00
NS160MHC	160	300	\$113.00
NS250MHC	250	390	\$201.00
NS315MHC	315	455	\$267.00
NS400MHC	400	540	\$369.00
NS450MHC	450	590	\$445.00

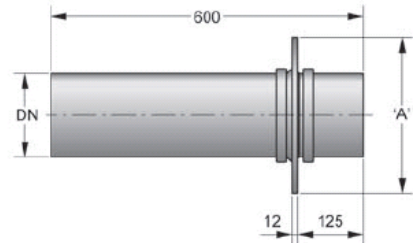

### External 45° Backdrop Junction Fitted with Hydrophilic Seals:

Product code	Typical Dimension		List \$ each
	Nominal Diameter DN (mm)	Dim. (mm) 'A'	
NS16045BDJ	160	300	\$312.00
NS25045BDJ	250	390	\$630.00

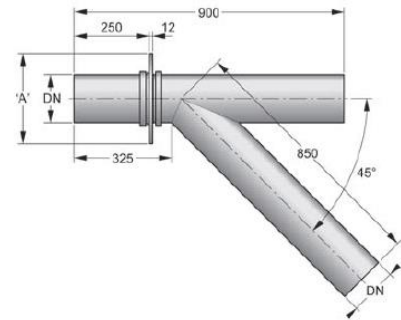

### Backdrop Tee Fitted with Hydrophilic Seals:

Product code	Typical Dimension				List \$ each
	Nominal Diameter DN (mm)	Dim. (mm) 'A'	Dim. (mm) 'B'	Dim. (mm) 'C'	
NS110BDT	110	550	275	250	\$225.00
NS160BDT	160	660	330	300	\$276.00
NS250BDT	250	800	400	390	\$630.00
NS315BDT	315	1160	580	455	\$938.00
NS400BDT	400	1500	600	540	\$1300.00

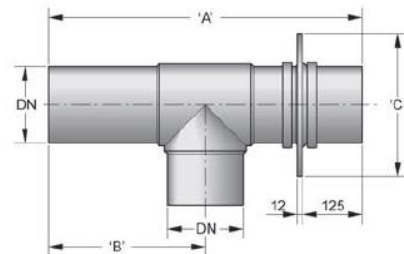

### Backdrop Bend Fitted with Hydrophilic Seals:

Product code	Typical Dimension				List \$ each
	Nominal Diameter DN (mm)	Dim. (mm) 'A'	Dim. (mm) 'B'	Dim. (mm) 'C'	
NS110BDB	110	230	275	250	\$135.00
NS160BDB	160	330	330	300	\$190.00
NS250BDB	250	375	400	390	\$456.00
NS315BDB	315	580	580	455	\$628.00
NS400BDB	400	900	900	540	\$1,100

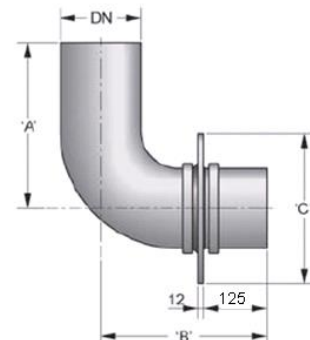

- All dimensions, masses & volumes are approximate only. If critical contact PE Solutions
- Unless otherwise stated all dimensions are in mm



## Nusewer System

### DN160 Internal Backdrop Bend:

Product code	Description	List \$ each
NS160IBDB	160x90D SewerPlex Bend PE100Int B/Drop	\$75.00



### Concrete Protection:

Product code	Description	List \$ p/Mtr
CPLY2.5	Concrete Protection Yellow 2.5m x50mx2.5mm	\$6,000.00
CPLB5	Concrete Protection Black 5mm Sheets	POA



- Cut to Size and Pre fabrication available on request
- PE Solutions also offers full onsite welding of liner & pre Fabrication & De Knobbing

### Vector Pipe Assembly c/w S/S Bracket & Air Line:

Product code	Description	List \$ p/Mtr
VP1604	Complete Vector Assembly 4m	\$4,750.00
VP1606	Complete Vector Assembly 6m	\$5,000.00
VP1608	Complete Vector Assembly 8m	\$5,250.00



- Lengths need to be advised at order total overall length

### S/S Wall Pipe c/w Poly Sleeve:

Product code	Description	List \$ p/Mtr
SSWP1506	S/S Wall Pipe c/w Poly Sleeve 6" T/D 4087	\$1,095.00
SSWP2008	S/S Wall Pipe c/w Poly Sleeve 8" T/D 4087	\$1,580.00
SSWP2509	S/S Wall Pipe c/w Poly Sleeve 9" T/D 4087	\$2,200.00

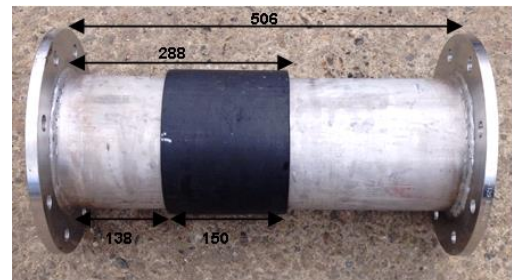

- Other Sizes available on request
- PE Solutions can offer a full range of S/S Fabrication



P: 3205 6668  
M: : 0414 511 502  
E: [admin@pesolutions.net.au](mailto:admin@pesolutions.net.au)  
ABN: 981 5991 0406

1 LEONARD CRESENT, BRENDALE QLD 4500  
PO BOX 5428, BRENDALE QLD 4500  
[www.pesolutions.net.au](http://www.pesolutions.net.au)

## Contact Us

---

PE Solutions Pty Ltd - Specialists in PE Fabrication & Supply

Location: 1 Leonard crescent Brendale Qld 4500

Postal: Po Box 5428 Brendale Qld 4500

Email & Web: [admin@pesolutions.net.au](mailto:admin@pesolutions.net.au) [www.pesolutions.net.au](http://www.pesolutions.net.au)

Phone: Ph: 07 3205 6668

General Manager: Brett Aldridge Mob: 0414 511 502 [brett@pesolutions.net.au](mailto:brett@pesolutions.net.au)

